

Rhpoint Instruments Ltd

Rhpoint Instruments Ltd.
Rhpoint House, Enviro 21 Park,
Queensway Avenue South, St. Leonards-on-Sea,
East Sussex, TN38 9AG
United Kingdom

Tel: +44 (0)1424 739622

Fax: +44 (0)1424 730600

Email: sales@rhpointinstruments.com

Website: www.rhpointinstruments.com

RHOPOINT

NOVO-SHADE DUO™

45/0° reflectometer

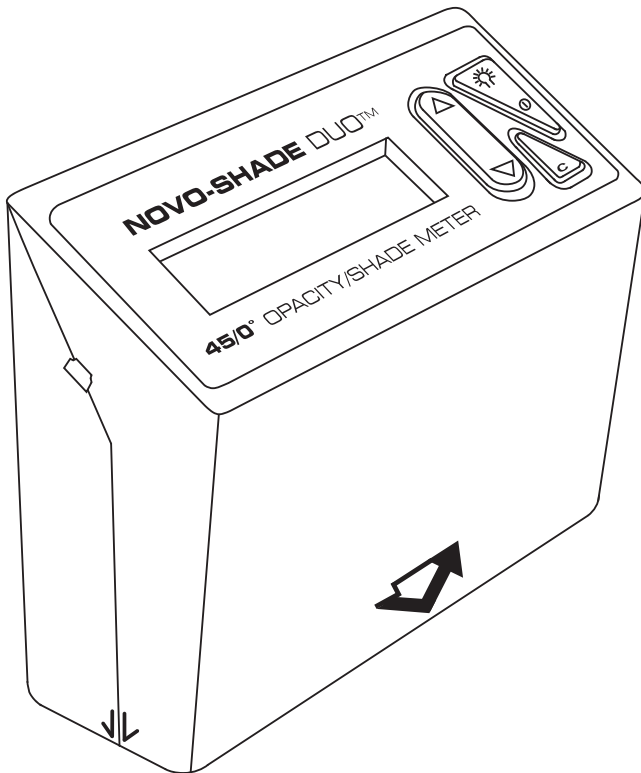

User Manual

Information in this document is subject to change without notice.
Companies, names and data used in examples herein are fictitious
unless otherwise noted.

© 2005 Rhopoint Instruments Ltd. All rights reserved.

Novo-Shade Duo™, Novo-Soft™, Novo-Gloss™, Novo-Curve™ and
Rhopoint™ are either registered trademarks or trademarks of Rhopoint
Instruments Ltd in the UK and other countries.

Other product and company names mentioned herein may be trademarks
of their respective owners.

Published by:

Rhopoint Instruments Ltd.
Rhopoint House, Enviro 21 Park,
Queensway Avenue South, St. Leonards-on-Sea,
East Sussex, TN38 9AG
United Kingdom

Tel: +44 (0)1424 739622

Fax: +44 (0)1424 730600

Email: sales@rhopointinstruments.com

Web: www.rhopointinstruments.com

Version 1.01 English – Revision C
September 2007

Document number: D5000-020C

Printed in the UK

Contents

- Features 2**
- Accessories 3**
- Power 4**
- The control panel 5**
- Calibration check 6**
- Calibration 7-9**
- Maintaining the Novo-Shade Duo™ and calibration tile 10**
- Before taking a reading 11**
- Choosing/switching between shade/opacity modes 12-13**
- Taking a single reflectance (shade) reading 14**
- Continuous reading mode 15**
- Measuring the opacity of a sample 16-17**
- Deleting data 18-19**
- Viewing statistics 20**
- Definition of terms used in statistical mode 21**
- Changing the configuration 22-24**
- Menu structure 25**
- Novo-Soft™ 26**
- Rhpoint Instruments – other products 27-28**
- Declaration of conformity 29**

Features

The Novo-Shade Duo™ instrument from Rhopoint™ is a dual function 45/0° reflectometer designed to assess the shade of flat surfaces or the opacity of coatings, paper and plastic films or any semi-opaque flat product.

- **Shade Mode** – assess the shade of any flat surface from black (0% reflectance) to brilliant white (100% reflectance)
- **Opacity Mode** – automatically calculate the opacity/hiding power of any sample measured over a black and white substrate or test plate
- 0.1% resolution
- Move and read feature for quick assessment of large surfaces
- Built-in statistical analysis
- Download and analyse results with Novo-Soft™ software
- Calibrate to any standard
- Automatic or manual calibration
- Automatic standard check during calibration
- Conforms to the following international standards:
 - ISO 2814
 - BS 3900-D4
 - ASTM E97
 - ASTM E1347
 - ISO 6504
 - ASTM D4214
 - ASTM D2805
- Life time light source guarantee.

Accessories

Included accessories for the Novo-Shade Duo™:

- Novo-Shade Duo™ 45/0° reflectometer
- Traceable black and white calibration tiles in protective case
- Traceability certificate for calibration tile
- Mini-CD containing Novo-Soft™ and PDF versions of manuals
- Registration card – for extended warranty
- Data cable (USB)
- Cleaning cloth
- 5 x AAA batteries (Dry cell version only)
- Instrument carry case
- Screwdriver

***Register your new Novo-Shade Duo™ at
www.rhopointinstruments.com
to qualify for an extended two year warranty***

Power (Dry cell)

The Novo-Shade Duo™ is supplied with 5 x AAA dry cell batteries.

To install or replace these batteries, first remove the battery panel by unscrewing the two screws. Place the cells in the battery clips as shown in figure 1.

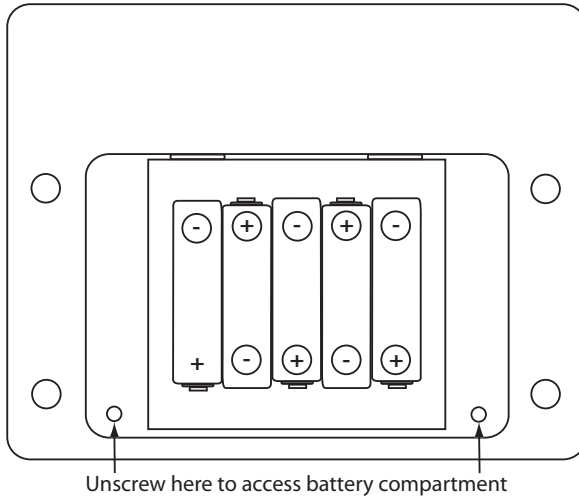

FIGURE 1. The battery unit

Replace the back panel and re-tighten the fixing screws.

Power (Rechargeable)

The Novo-Shade Duo™ is fitted with a long life lithium battery. The battery can be charged by connecting the instrument to the PC USB port, or supplied mains charger.

A full charge takes approximately 4hrs.

The control panel

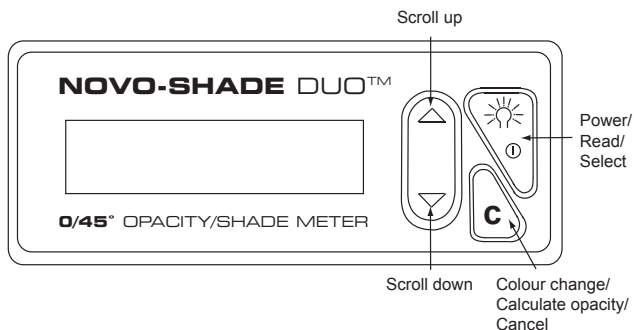

FIGURE 2. The Novo-Shade Duo™ control panel



Read/select key

This key has three functions:

- Power: This key is used to turn the instrument on after a power down
- Read: In measurement mode pressing this key initiates a new measurement
- Select: When navigating through the set-up menus this key selects an item or confirms a previous selection

**Note: The instrument has a user definable power down time. This can be adjusted by connecting the instrument to a PC and changing the power down time (30-120 seconds) in the preferences in Novo-Soft™.*



Scroll up/scroll down

This key is used to navigate the set-up and operation menus in the Novo-Shade Duo™. It is also used to change the calibration value in the calibration set-up menu.



Colour change/calculate opacity/cancel key

In opacity mode this key switches between black and white measurements, once measurements are completed this key should be pressed and held for three seconds to calculate opacity.

During calibration this key is used to cancel the process and revert to previously stored calibration constants.

Calibration check

It is necessary for the user to visually inspect the calibration tile for smears or defects before calibration.

The instrument will also automatically check the condition of the standard tile. If the reading is outside calibration tolerances the following warning messages will be seen:

Poss. Cal. Error
Check Calib tile

Accept new
Calibration?

ARE YOU SURE?
Press Read Key

The white tile must be checked for permanent marks and deep scratches. If these are seen on the tile the CLEAR key should be pressed – the calibration value will not be stored. The tile must then be carefully cleaned and inspected. The calibration procedure must then be repeated. See page 12 for cleaning procedure.

**Note: If there are permanent marks or scratches the tile must be returned for recalibration by Rhopoint Instruments.*

Checking the calibration value

Place the instrument on the white calibration tile and take a reading by pressing the READ/SELECT key.

Compare the measured value with the assigned value of the tile. If the value matches the value printed on the tile case the instrument is within calibration and ready for use.

If the readings do not match it will be necessary to check the value for the tile stored in the instrument memory – see the ‘Set calibration value’ section (page 24).

Calibration

Initial calibration notes

Before taking a reading it is necessary to check the calibration of the instrument. Follow the calibration check procedure (see page 8).

Calibration mode – automatic or manual

The Novo-Shade Duo™ has two user-selectable calibration methods. It can be switched between automatic and manual modes by connecting to a PC and altering the setting in the preference file in Novo-Soft™.

**Note: The instrument is supplied in default automatic calibration mode.*

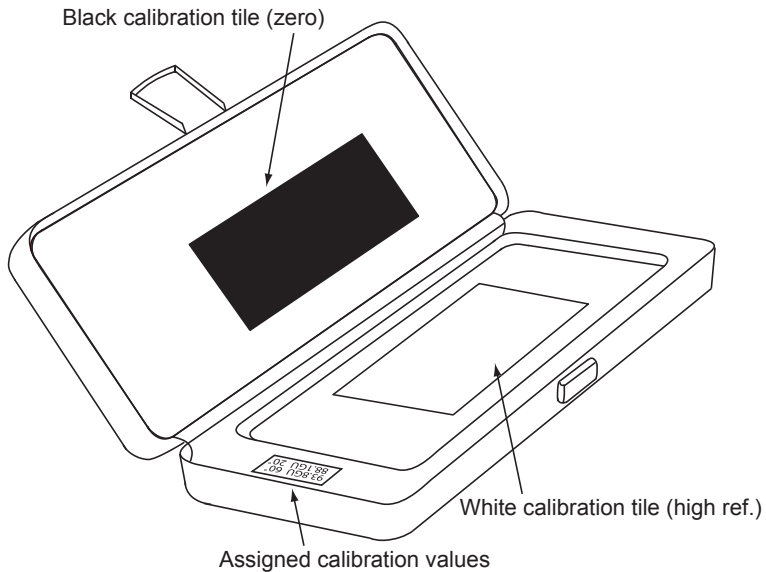

FIGURE 3. The Novo-Shade Duo™ calibration standard

**Note: The black zero tile is supplied certified in a clean and defect free condition. A visual inspection for smears or damage is recommended before each subsequent calibration as dirty or defective tiles may lead to inaccurate measurement. The white reflectance tile should also be checked for any deep scratches, marks or fingerprints. (See page 10 for tile cleaning procedure.)*

Calibration

The instrument calibration procedure is as follows:



To turn the instrument on press the POWER key. For two seconds the display will show the following message:

```
Rhopoint
Novo-Shade Duo
```

The display will then indicate the current measurement mode of the instrument.

```
Rhopoint
Shade Mode
```

```
Rhopoint
Opacity Mode
```

Note: To switch between measurement modes see page 15

After a further two seconds the instrument will revert to measurement mode as seen below:

```
ANGLE  Value  No.
45/0   99.4    7
```

Shade mode

```
WHITE  Value  No.
45/0   99.4    7
```

Opacity mode

To calibrate in shade mode hold down 'C' key

```
CALIBRATE ANGLE
Press Read Key
```



Press the READ/SELECT key to start the procedure.

```
ARE YOU SURE?
Press Read Key
```



Press the READ/SELECT key to confirm your selection.

The display now reads:

```
Calibrate
Sample Black Ref
```

Calibration (continued)

Place the instrument on the black zero value tile. (See figure 4.)



Press the READ/SELECT key to set the zero value. The instrument will then prompt:

```
Calibrate  
Sample White Ref
```



Place the instrument on the white reference standard. Press the READ/SELECT key when it is in position.

The instrument will then display:

```
45/0 ANGLE  
Completed
```

The instrument is then calibrated and ready for use.

To calibrate in opacity mode hold down ∇ + 'C' keys to enter menu.



Press the READ/SELECT key to start the procedure.

```
ARE YOU SURE?  
Press Read Key
```



Press the READ/SELECT key to confirm your selection.

The display now reads:

```
Calibrate  
Sample Black Ref
```

Maintaining the Novo-Shade Duo™ and calibration tile

The tiles should be checked to ensure that they are clean and in good condition. If necessary the tile may be wiped with a cloth moistened with warm soapy water and dried with a lint-free cloth.

Marks on the surface of the white reflectance tile should be removed by carefully scraping the surface with a scalpel. For accurate calibration a flat surface must be maintained. If the tile is damaged with deep scratches a replacement tile must be purchased.

It is important that tiles have an up-to-date certificate. Recalibration is normally required every 12 months.

The instrument should be checked to ensure the metal base plate is clean. Care should always be taken to avoid damage to the instrument base plate. The optic cavities and lenses must also be free of dust and other contamination.

Before taking a reading

Calibration check

If the instrument has not been used for some time it is advisable to check the calibration. Place the instrument on the white calibration tile.

Take a reading by pressing the READ/SELECT key. Compare the measured value with the assigned value for the tile. If it matches the value printed on the tile case, the instrument is within calibration and ready for use.

If the value does not match the assigned value, follow the calibration check procedure on page 6.

If the measured value matches the assigned value for the tile the instrument is ready for use.

Positioning the instrument

When the instrument is placed on the sample to be measured the aperture is hidden, but its position can be pinpointed by the intersection of the arrows marked on the front of the instrument case with those on the side (see figure 4).

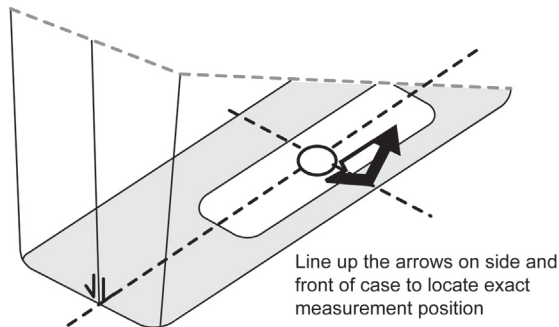

FIGURE 4. Locating the Novo-Shade Duo™ for a measurement

Choosing between Shade and Opacity modes

Measuring using 45/0° geometry, the Novo-Shade Duo™ excludes the surface specular reflectance (gloss) component and looks only at the colour or shade.

Shade mode – the measured value can be used to grade surfaces from black (0% reflectance) to brilliant white (100% reflectance). Coloured surfaces can also be measured; the value will indicate the luminous intensity of the colour (lightness/darkness).

Opacity mode – the sample must be drawn down on or measured over a substrate with black and white portions. The instrument uses these measurements to automatically calculate the hiding power or opacity of the sample.

Switching between Shade and Opacity modes



To turn the instrument on press the POWER key. For two seconds the display will show the following message:

Rhopoint
Novo-Shade Duo

The display will then indicate the current measurement mode of the instrument.

Rhopoint
Shade Mode

Rhopoint
Opacity Mode

After two seconds it then will revert to measurement mode.

ANGLE	Value	No.
45/0	99.4	7

Shade mode

WHITE	Value	No.
45/0	99.4	7

Opacity mode

Press and hold down ∇ + 'C' keys to enter menu.



Use the SCROLL UP/DOWN key to select the following option:

System Set-Up
Press Read Key



Press the READ key to confirm your selection.

continued...

Choosing between Shade and Opacity modes

(continued)



Use the SCROLL UP/DOWN key to select the following option:

```
Select Inst Type
Press Read Key
```



Press the READ key to confirm your selection.

The display will read:

```
Opacity Inst.
Press Read Key
```

Shade mode

```
Shade Inst.
Press Read Key
```

Opacity mode



Use the SCROLL UP/DOWN key to cycle between these two options.



When the instrument mode required is displayed, press the READ key.

The instrument will prompt:

```
Inst type change
Old data LOST!
```

```
Are you sure?
Press Read Key
```



Press the READ key to change the instrument type.

Please note that changing between Opacity and Shade instrument will reset the internal memory – any readings that have not been downloaded to PC will be permanently lost.

Press the C key to cancel the change and revert to previous measurement mode with memory intact.

Taking a single reflectance (shade) measurement



Turn the instrument on by pressing the POWER key. For two seconds the display will show the following message:

Rhopoint Novo-Shade Duo

The display will then indicate the current measurement mode of the instrument.

Rhopoint Shade Mode

**Note: To take reflectance readings the instrument should be set to Shade mode. For the procedure to switch between modes see pages 14-15.*

After a further two seconds the instrument will revert to measurement mode as seen below:

ANGLE	Value	No.
45/0	0	0



Press the READ key to initiate a reading. A line of arrows will move across the screen whilst the instrument takes a measurement.

ANGLE	Value	No.
45/0>>>>>		

Once the instrument has taken the reading the display will show the results as in the example below:

1.	ANGLE	Value	No.	2.
	45/0	→ 99.7	← 1	

1. The value shown in the display is the reflectance value for the section of the sample covered by the aperture.
2. This value has been stored in the memory and the number of stored readings increased by one.

Continuous reading mode

Using the move and read feature

The Novo-Shade Duo™ has a unique feature to quickly assess large surfaces for shade variations.

To use this feature press and hold the READ/SELECT key.

The unit will now start to take a reading and a line of arrows will move across the screen whilst the instrument takes the measurement.

A value will be shown in the display – this is the reflectance value for the part of the sample currently covered by the measurement aperture.

To assess the rest of the sample continue to hold the READ/SELECT key and carefully slide the instrument to the next area to be inspected.

The value in the display will update in real time to reflect the shade value of the surface under the aperture at that time.

As soon as the READ/SELECT button is released the last value measured will be displayed. This is also the value stored in the memory.

Taking subsequent readings

Repeat the above procedure to take further readings. Each time a reading is taken the number of samples stored increases by one. If an erroneous measurement is taken it can be deleted (see pages 20-21).

Measuring the opacity of a sample

To measure the opacity of a coating it must be drawn down on a Leneta type opacity chart at the required film weight and allowed to fully dry.

To measure the opacity of plastic film, paper, textile or any other semi-opaque material, place the sample to be measured over a black and white test bed.



Turn the instrument on by pressing the POWER key. For two seconds the display will show the following message:

Rhopoint Novo-Shade Duo

The display will then indicate the current measurement mode of the instrument.

Rhopoint Opacity Mode

**Note: To take reflectance readings the instrument should be set to Opacity mode. For the procedure to switch between modes see pages 14-15.*

After a further two seconds the instrument will revert to measurement mode as seen below:

WHITE	Value	No.
45/0	0	0

The text on the top left hand side of the instrument display indicates the part of the sample to be measured. In the above example 'WHITE' is indicated. Up to six positions on the sample over the white substrate should now be measured.



Press the READ key to initiate a reading. A line of arrows will move across the screen whilst the instrument takes a measurement and the display will show the results as in the example below.

WHITE	Value	No.
45/0	89.7	1

Repeat this to take up to five further measurements as necessary.

Measuring the opacity of a sample (continued)

The instrument can now be switched so that the sample can be measured over the black substrate.



Press the C button to CHANGE.

BLACK	Value	No.
45/0	0	0

Up to six measurements should now be made over the black substrate.



Press the READ key to initiate a reading. A line of arrows will move across the screen whilst the instrument takes a measurement and the display will show the results as in the example below:

BLACK	Value	No.
45/0	69.7	4

It is possible to switch between black and white measurements at any time (by pressing the C button to change) and make up to six measurements on each part of the sample.

When all the necessary measurements have been made the calculation of opacity can be initiated.



To combine the results the C button must be pressed and held for three seconds. The display will read as follows:

Blk/Wht	Batch
45/0	69.7 4

Are you sure?
Press Read Key



Press the READ key to confirm opacity calculation.

The instrument will calculate the opacity and the display will show the results as in the example below:

BATCH	H.power
3	94.5%

Deleting data

Deleting single readings



Press the SCROLL UP/DOWN key until either of the following messages is displayed:

Delete sample?
45/0 97.6 4

Shade mode

Delete sample?
WHITE 90.6 3

Opacity mode



Press the READ/SELECT key. The display will show the following message:

Are you sure?
Press Read Key



Press the READ/SELECT key to confirm your selection. The last sample will then be deleted.

The display will prompt you for further deletions as shown below:

Delete sample?
45/0 94.2 3

Shade mode

Delete sample?
WHITE 91.2 2

Opacity mode



You can then continue to delete further single samples by pressing the READ/SELECT key



To return to measurement mode press the SCROLL UP/DOWN key until the display shows the measurement mode:

WHITE	Value	No.
45/0	89.7	1

Deleting data (continued)

Clearing the instrument memory



Press the SCROLL UP/DOWN key until either of the following messages is displayed:

Delete sample?			
45/0	97.6		4

Shade mode

Delete sample?			
WHITE	90.6		3

Opacity mode



Press and HOLD the READ/SELECT key for four seconds. The display will show the following for two seconds:

Del All Results

Then it will display the following message:

Are you sure?
Press Read Key



Press the READ/SELECT key to confirm your selection. ALL samples will then be deleted.

The display will then read:

Delete sample?			
45/0	0		0

Shade mode

Delete sample?			
WHITE	0		0

Opacity mode

To return to measurement mode press the SCROLL UP/DOWN key until the display shows the measurement mode:

ANGLE	Value	No.
45/0	0	0

Shade mode

ANGLE	Value	No.
45/0	0	0

Opacity mode

**Note: In opacity mode all batched opacity information is also cleared from the memory.*

Analysing statistics



To turn the instrument on press the POWER key. For two seconds the display will show the following message:

Rhopoint Novo-Shade Duo

The display will then indicate the current measurement mode of the instrument.

Rhopoint Shade Mode

Rhopoint Opacity Mode



Press the SCROLL UP/DOWN button until the statistics window is displayed as shown in the following examples:

STATS	MIN	MAX
45/0	87.5	97.6

Shade mode

STATS	MIN	MAX
H.POW	95.5	97.6

Opacity mode



To display the rest of the statistics for the batch, press the READ/SELECT key to see the results as in the following example:

MEAN	CV	SD
89.2	0.12	0.87



Press the SCROLL UP/DOWN key at any time to exit the statistic screen and return to measurement mode.

In **Shade** mode the statistics are calculated for all reflectance measurements stored in the memory.

In **Opacity** mode the statistics are calculated for all batched opacity values, therefore no statistics will be seen until the opacity has been calculated least one set of readings (see page 16 for instructions on calculating opacity).

Definitions of terms used in statistical mode

For this purpose the individual readings are defined as values x_1, x_2, \dots, x_n , and x_i is any data point:

- Statistical sample population. n – the current number of stored readings (STORE), on which the statistical analysis is based
- Maximum (MAX) – the highest reading
- Minimum (MIN) – the lowest reading
- Mean (MEAN) – the sum of all readings divided by the total number

$$\bar{x} = \sum_{i=1}^{i=n} \frac{x_i}{n}$$

- Standard deviation (SD). s – square root of the sum of squared deviations from the mean

$$s = \sum_{i=1}^{i=n} \left(\frac{x_i^2 - \bar{x}^2}{(n-1)} \right)^{\frac{1}{2}}$$

- Coefficient of variation (CV). c – standard deviation divided by the mean, a measure of data scatter

$$c = \frac{s}{\bar{x}} = \sum_{i=1}^{i=n} \frac{n}{x_i} \left(\frac{x_i^2 - \bar{x}^2}{(n-1)} \right)^{\frac{1}{2}}$$

Changing the configuration

The calibration value

This is the value that the instrument calibrates to and must match the certified value of the supplied calibration standard. It does not need to be altered before use as the correct value is stored before the instrument leaves the Rhopoint Instrumentation laboratory.

If it becomes necessary to change the stored value, for example if the tile is re-calibrated by Rhopoint Instruments or you choose to use a different standard, then use the following procedure.

Changing the calibration value



To turn the instrument on press the POWER key. Wait for the instrument to revert to measurement mode:

ANGLE	Value	No.
45/0	0	0

Shade mode

WHITE	Value	No.
45/0	0	0

Opacity mode

Press and hold down ∇ + 'C' keys, the following message is displayed:

System Set Up Press Read Key



Press the READ/SELECT key to enter this menu and the following message will be displayed. Press the READ/SELECT key to activate this option.



SET STD CAL VAL. 45/0° 93.2

SET STD CAL VAL. Mode activated



Use the SCROLL UP/DOWN keys to adjust the value until it matches the value quoted on the calibration tile certificate.



When the displayed value is correct press READ/SELECT to store the value. The instrument will confirm this with the following message:

CAL DATA STORED Completed

The instrument will then return to measurement mode and must be re-calibrated before this value is used.

Changing the configuration (continued)

Switching on/off the backlight

To extend the life of the batteries it is possible to switch off the display backlight. To switch on/off this function follow the following procedure.



To turn the instrument on press the POWER key. Wait for the instrument to revert to measurement mode:

ANGLE	Value	No.
45/0	0	0

Shade mode

WHITE	Value	No.
45/0	0	0

Opacity mode

Press and hold down ∇ + 'C' keys, the following message is displayed:

System Set Up Press Read Key



Press the READ/SELECT key to enter this menu. Press the SCROLL UP/DOWN keys until the following message is displayed:

Back Light Opps Press read key



Press the READ/SELECT key to turn on/off the backlight.



To return to the measurement mode, press the SCROLL UP/DOWN key until the following message is displayed and then press the READ/SELECT key.



Exit Set-up Press read key

Changing the language

The language displayed by the instrument can be changed by connecting the instrument to a PC and changing the preferences in Novo-Soft™.

Changing the configuration (continued)

Turn on/off statistics

For a less complicated operation users may want to take gloss readings without storing the samples. The non-statistical mode can be activated/deactivated using the following procedure.



To turn the instrument on press the POWER key. Wait for the instrument to revert to measurement mode:

ANGLE	Value	No.
45/0	0	0

Shade mode

WHITE	Value	No.
45/0	0	0

Opacity mode

Press and hold down ∇ + 'C' keys, the following message is displayed:

```
System Set Up
Press Read Key
```



Press the READ/SELECT key to enter this menu. Press the SCROLL UP/DOWN keys until the following message is displayed:

```
Stats. mode
Press read key
```



Press the READ/SELECT key to turn on/off the statistical mode.



To return to the measurement mode, press the SCROLL UP/DOWN key until the following message is displayed and then press the READ/SELECT key.



```
Exit Set-up
Press read key
```

Novo-Shade Duo™ Menu Structure

Measurement Mode

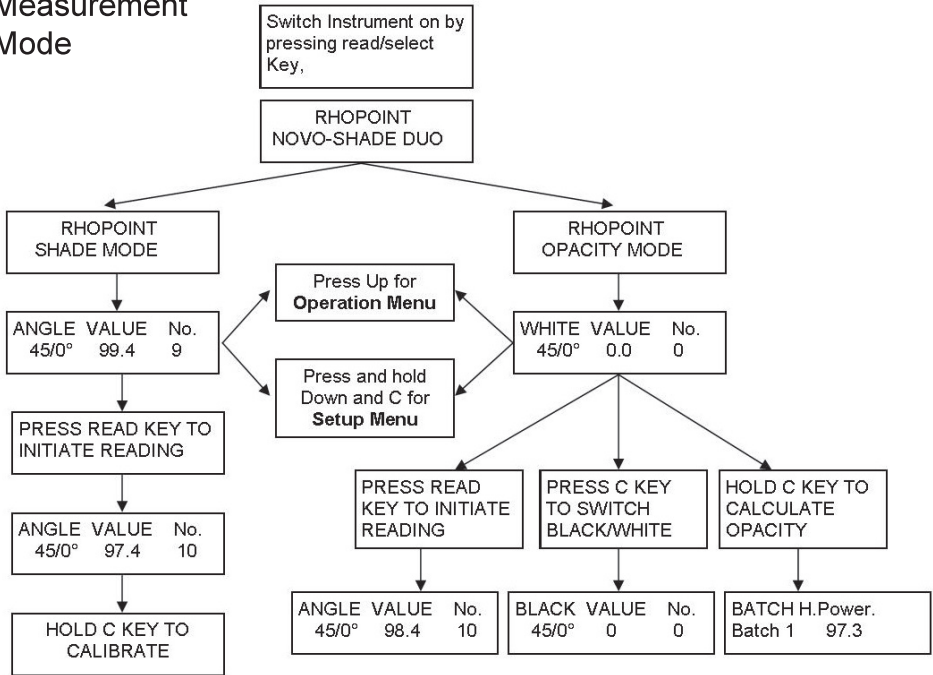

Operation Menu

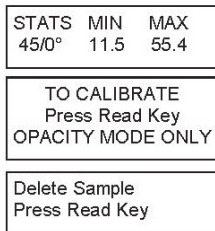

Setup Menu

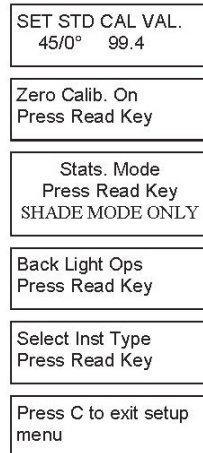

Novo-Soft™

The instrument is supplied with Novo-Soft™ quality control software. This package allows the user to download, analyse and store sample batches from Rhopoint Instruments. The user can also alter certain settings in the Novo-Shade Duo™ using this software.

Installing

Insert the Novo-Soft™ mini CD into a windows based PC with a USB port. When the drive is closed the installation wizard will start. Follow the on-screen instructions to complete the installation procedure.

Running

From the PC select START>ALL PROGRAMS>NOVO SOFT.
The Novo-Soft™ software will then execute.

Connecting the Novo-Shade Duo™

The supplied USB data cable must be plugged into an available COM port on the user's PC.

The mini USB cable must then be plugged into the USB data connection socket on the side of the Novo-Shade Duo™ (see figure 5).

Refer to instructions on CD case.

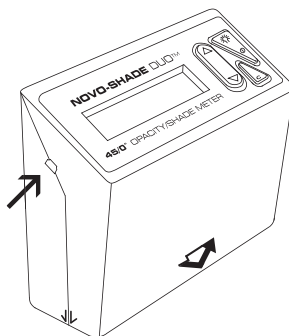

FIGURE 5. The USB data connection socket

Downloading and analysing results

Full instructions on how to download and analyse samples can be found in the Novo-Soft™ help feature, accessed from the software main screen. On-screen prompts to help you with this are also a feature of Novo-Soft™.

Changing settings in the Novo-Shade Duo™

Settings that can be changed using Novo-Soft™ are; language, stored calibration values and the choice of automatic or manual calibration. From the software main screen click on 'Preferences' to access these options.

Rhpoint Instruments – other products

Rhpoint Instruments design and manufacture a complete range of optical test instruments under the Novo trade mark. These precision instruments include the Novo-Gloss™ and Novo-Curve™ range of gloss meters, Novo-Pac™ and Novo-Shade™ 0/45° reflectometers.

Also manufactured by Rhpoint Instruments are the Minimum Film Forming Temperature Bar™ (MFFTBar) – specialist laboratory equipment to predict and quantify the performance of thin films.

Novo-Curve™

This instrument has the unique ability to measure the gloss over a small area on a curved surface. The applications for the instrument can be found in a wide range of industries. To follow are just a few examples:

Plastics industry – checking the appearance and visual conformity of plastic moulded parts such as car trims, mobile phone cases, etc.

Metal finishing – checking the quality of surface finish and plating on products from bathroom fittings, quality writing pens and the effectiveness of polished metal surfaces.

Cosmetics and packaging industry – the surface finish of glass, plastic bottles and promotional packaging.

In addition to the above applications there are many diverse uses including checking holograms on bank notes and research applications in the dental industry.

The instrument is able to take batch readings and features built in statistical analysis. Continuous readings can also be made to assess the gloss across the surface of almost any sample large or small. There is a simple jiggling arrangement to position the sample to be measured so that consistent measurements can be made on small parts.

Novo-Gloss™

A complementary range to the Novo-Shade Duo™, these hand held instruments are based around a durable solid aluminium optic block.

Available in single, dual and triple angle format, with or without statistical analysis, they can be purchased in a format which suits the end-user's application and budget.

All instruments are user serviceable and comply with all necessary international standards for gloss measurement.

They come supplied with calibration tiles certified and traceable to national standards.

Many of the features associated with the Novo-Shade Duo™ are available on the Novo-Gloss™ range (move and read, downloadable statistics, etc).

They are available in all important measuring geometries – 20°, 45°, 60°, 75° and 85° angles.

MFFT™

The Minimum Film Forming Temperature Bar™ is an accurate temperature controlled platen that is used to predict the performance of thin films at different temperatures. It is primarily used by the coating industry to study the coalescence of water based formulations.

EC DECLARATION OF CONFORMITY

WE Rhopoint Instruments Ltd.
Rhopoint House, Enviro 21 Park, Queensway Avenue South,
St. Leonards-on-Sea, East Sussex, TN38 9AG, UK

DECLARE UNDER OUR SOLE RESPONSIBILITY THAT THE PRODUCTS

Novo-Gloss Lite USB
Novo-Shade Duo USB

**TO WHICH THIS DECLARATION RELATES ARE IN CONFORMITY WITH
THE FOLLOWING STANDARDS**

EN61326:1997 A1, A2, A3

FOLLOWING THE PROVISIONS OF DIRECTIVES

2004/108/EC

Rhopoint Instruments Ltd
30 May 2007



.....
Daniel Smith, Research and Development Technician